



LCD PROJECTOR

MODEL

SE1U

User Manual

SE1

Others

Maintenance

Operations

Preparations

Before Using



CAUTION
RISK OF ELECTRIC SHOCK
DO NOT OPEN

CAUTION: TO REDUCE THE RISK OF ELECTRIC SHOCK,
DO NOT REMOVE COVER (OR BACK)
NO USER-SERVICEABLE PARTS INSIDE
REFER SERVICING TO QUALIFIED
SERVICE PERSONNEL.



The lightning flash with arrowhead symbol within an equilateral triangle is intended to alert the user to the presence of uninsulated "dangerous voltage" within the product's enclosure that may be of sufficient magnitude to constitute a risk of electric shock.



The exclamation point within an equilateral triangle is intended to alert the user to the presence of important operating and maintenance (servicing) instructions in the literature accompanying the appliance.

WARNING:

TO PREVENT FIRE OR SHOCK HAZARD, DO NOT EXPOSE THIS APPLIANCE TO RAIN OR MOISTURE.

CAUTION:

TO PREVENT ELECTRIC SHOCK, DO NOT USE THIS (POLARIZED) PLUG WITH AN EXTENSION CORD, RECEPTACLE OR OTHER OUTLET UNLESS THE BLADES CAN BE FULLY INSERTED TO PREVENT BLADE EXPOSURE.

NOTE:

SINCE THIS PROJECTOR IS PLUGGABLE EQUIPMENT, THE SOCKET-OUTLET SHALL BE INSTALLED NEAR THE EQUIPMENT AND SHALL BE EASILY ACCESSIBLE.

WARNING

Use the attached specified power supply cord. If you use another power-supply cord, it may cause interference with radio and television reception.

Use the attached RGB cable with this equipment so as to keep interference within the limit of a FCC Class B device.

This apparatus must be grounded.

DO NOT LOOK DIRECTLY INTO THE LENS WHEN THE PROJECTOR IS IN THE POWER ON MODE.

CAUTION

Not for use in a computer room as defined in the Standard for the Protection of Electronic Computer/Data Processing Equipment, ANSI/NFPA 75.

When using the projector in Europe:

COMPLIANCE NOTICE

This LCD Projector complies with the requirements of the EC Directive 89/336/EEC "EMC Directive" as amended by Directive 92/31/EEC and 93/68/EEC, and 73/23/EEC "Low Voltage Directive" as amended by Directive 93/68/EEC.

The electro-magnetic susceptibility has been chosen at a level that gains proper operation in residential areas, on business and light industrial premises and on small-scale enterprises, inside as well as outside of the buildings. All places of operation are characterised by their connection to the public low voltage power supply system.

WARNING

Use the attached RGB cable with this equipment so as to keep interference within the limits of an EN55022 Class B device. Please follow WARNING instructions.

IMPORTANT SAFEGUARDS

Please read all these instructions regarding your LCD projector and retain them for future reference. Follow all warnings and instructions marked on the LCD projector.

1. Read instructions
All the safety and operating instructions should be read before the appliance is operated.
2. Retain instructions
The safety and operating instructions should be retained for future reference.
3. Warnings
All warnings on the appliance and in the operating instructions should be adhered to.
4. Instructions
All operating instructions must be followed.
5. Cleaning
Unplug this projector from the wall outlet before cleaning it. Do not use liquid aerosol cleaners. Use a damp soft cloth for cleaning.
6. Attachments and equipment
Never add any attachments and/or equipment without the approval of the manufacturer as such additions may result in the risk of fire, electric shock or other personal injury.
7. Water and moisture
Do not use this projector near water or in contact with water.
8. Accessories
Do not place this projector on an unstable cart, stand, tripod, bracket or table. Use only with a cart, stand, tripod bracket, or table recommended by the manufacturer or sold with the projector. Any mounting of the appliance should follow the manufacturer's instructions and should use a mounting accessory recommended by the manufacturer.



An appliance and cart combination should be moved with care. Quick stops, excessive force and uneven surfaces may cause the appliance and cart combination to overturn.

9. Ventilation
Slots and openings in the cabinet are provided for ventilation, ensuring reliable operation of the projector and to protect it from overheating. Do not block these openings or allow them to be blocked by placing the projector on a bed, sofa, rug, or bookcase. Ensure that there is adequate ventilation and that the manufacturer's instructions have been adhered to.
10. Power sources
This projector should be operated only from the type of power source indicated on the marking label. If you are not sure of the type of power, please consult your appliance dealer or local power company.

IMPORTANT SAFEGUARDS (Continued)

11. Power-cord protection
Power-supply cords should be routed so that they are not likely to be walked on or pinched by items placed upon or against them. Pay particular attention to cords at plugs, convenience receptacles, and points where they exit from the appliance. Do not put the power cord under a carpet.
12. Overloading
Do not overload wall outlets and extension cords as this can result in a fire or electric shock.
13. Objects and liquids
Never push objects of any kind through openings of this projector as they may touch dangerous voltage points or short-out parts that could result in a fire or electric shock. Never spill liquid of any kind on the projector.
14. Servicing
Do not attempt to service this projector yourself. Refer all servicing to qualified service personnel.
15. Damage requiring service
Unplug this projector from the wall outlet and refer servicing to qualified service personnel under the following conditions:
 - (a) If the power-supply cord or plug is damaged.
 - (b) If liquid has been spilled, or objects have fallen into the projector.
 - (c) If the projector does not operate normally after you follow the operating instructions. Adjust only those controls that are covered by the operating instructions. An improper adjustment of other controls may result in damage and may often require extensive work by a qualified technician to restore the projector to its normal operation.
 - (d) If the projector has been exposed to rain or water.
 - (e) If the projector has been dropped or the cabinet has been damaged.
 - (f) If the projector exhibits a distinct change in performance - this indicates a need for service.
16. Replacement parts
When replacement parts are required, be sure that the service technician has used replacement parts specified by the manufacturer or parts having the same characteristics as the original part. Unauthorized substitutions may result in fire, electric shock or other hazards.
17. Safety check
Upon completion of any service or repair to this projector, ask the service technician to perform safety checks determining that the projector is in a safe operating condition.

WARNING:

Unplug immediately if there is something wrong with your projector.

Do not operate if smoke, strange noise or odor comes out of your projector. It may cause fire or electric shock. In this case, unplug immediately and contact your dealer.

Never remove the cabinet.

This projector contains high voltage circuitry. An inadvertent contact may result in an electric shock. Except as specifically explained in User Manual, do not attempt to service this product by yourself. Please contact your dealer when you want to fix, adjust, or inspect the projector.

Do not modify the projector.

It can lead to fire or electric shock.

Do not keep using the damaged projector.

If the projector is dropped and the cabinet is damaged, unplug the projector and contact your dealer for inspection. It may lead to fire if you keep using the damaged projector.

Do not face the projection lens to the sun.

It can lead to fire.

Use correct voltage.

If you use incorrect voltage, it can lead to fire.

Do not place the projector on uneven surface.

Place the projector on a level and stable surface only.

Do not look into the lens when the projector is operating.

It may hurt your eyes. Never let children look into the lens when the projector is on.

Do not unplug the power cord during operation.

It can lead to lamp breakage, fire, electric shock or other trouble. Wait for the fan to stop before unplugging the power cord.

Do not touch the air outlet grilles and bottom plate.

Do not touch them or put other equipment close to the air outlet grilles because they become hot during operation. The heated air outlet grilles and bottom plate may cause injury or damage to other equipment. Also, do not put the projector on a desk that is easily affected by heat.

Clean the air-filter once a month.

Clean the air-filter frequently. If the filter or ventilation slots become clogged with dirt or dust, the temperature inside of the projector may rise and cause some troubles, such as damage of inside parts, and shortening the life of the panels.

Do not look into the air outlet grilles when projector is operating.

Heat, dust, etc. may blow out of them and hurt your eyes.

This product contains chemicals, including lead, known to the State of California to cause cancer, and birth defects or other reproductive harm.
Wash hands after handling.

IMPORTANT SAFEGUARDS (Continued)

Place of installation

For safety's sake, do not use the projector at any place subjected to high temperature and high humidity. Please maintain an operating temperature, humidity, and altitude as specified below.

- Operating temperature: between +32°F (0°C) and +95°F (+35°C)
- Operating humidity: between 30% and 70%
- Never put any heat-producing device under the projector to prevent the projector from being overheated.
- Do not install the projector at a place that is unstable or subject to vibration.
- Do not install the projector near any equipment that produces a strong magnetic field. Also refrain from installing the projector near any cable carrying a large amount of current.
- Place the projector on a solid, vibration-free surface. Otherwise it may fall, causing serious injury or damage.
- Do not stand the projector on its end. It may fall, causing serious injury or damage.
- Slanting the projector more than $\pm 10^\circ$ (right and left) or $\pm 20^\circ$ (front and rear) may cause trouble or explosion of the lamp.
- Do not place the projector near air-conditioning unit or heater to avoid the air outlet and inlet grilles from being exposed to hot air.

COMPLIANCE NOTICE OF FCC

This equipment has been tested and found to comply with the limits for a Class B digital device, pursuant to Part 15 of the FCC Rules. These limits are designed to provide reasonable protection against harmful interference in a residential installation. This equipment generates, uses and can radiate radio frequency energy and, if not installed and used in accordance with the instructions, may cause harmful interference to radio communications. However, there is no guarantee that interference will not occur in a particular installation. If this equipment does cause harmful interference to radio or television reception, which can be determined by turning the equipment off and on, the user is encouraged to try to correct the interference by one or more of the following measures:

- Reorient or relocate the receiving antenna.
- Increase the separation between the equipment and receiver.
- Connect the equipment into an outlet on a circuit different from that to which the receiver is connected.
- Consult the dealer or an experienced Radio / TV technician for help.

Changes or modifications not expressly approved by Mitsubishi could void the user's authority to operate this equipment.

COMPLIANCE NOTICE OF INDUSTRY CANADA

This Class B digital apparatus complies with Canadian ICES-003.

ABOUT LAMP

The lamp is designed to project the image on the LCD panels. When the lamp no longer functions, replace it with a new one.

Caution:

- Do not remove the lamp immediately after using the projector. You may get burned because the lamp is very hot after use.
- Before replacing the lamp, press the POWER button to turn off the lamp and wait for two minutes for the lamp and LCD panels to cool down. Unplug the power cord from the wall outlet and wait one hour for the lamp to cool down completely.
- Do not remove the lamp except for replacement. Careless handling can cause injury or fire.
- Do not touch the lamp directly. It may break and cause injury or burn.
- Be sure not to drop the lamp lid screw into the projector. Also be sure not to put metal or any flammable objects inside because it may cause fire or electric shock. If any objects should fall inside, unplug and contact your dealer.
- Install the lamp securely to prevent failure and fire.
- If the lamp should break, small glass fragments may fall out through the grilles and some may remain inside of the projector or the lamp box. When taking the lamp box out, be sure to turn over the projector and hold the handle of the lamp box to avoid injury due to the glass fragments.
- If the lamp should break, never shake the lamp box or hold it in front of your face after removing it. The glass fragments may fall out and cause injury to your eyes.
- The lamp is fragile. If it is broken, be careful not to cut yourself with glass fragments.
- The replacement span of the lamp depends on the environment. For replacement lamps, please contact your dealer.
- This projector uses a lamp that contains mercury. Disposal of the lamp or the projector with the lamp may be regulated due to environmental considerations. For disposal or recycling information, please contact your local authorities or the Electronic Industries Alliance: www.eiae.org. (For US only).

ABOUT REMOTE BATTERIES

Caution:

- Use of a battery of wrong type may cause explosion.
- Dispose of used batteries according to the instructions. Batteries may explode if misused. Do not recharge, disassemble, or dispose of in fire.
- Be sure to handle the battery according to the instructions.
- Load the battery with its positive (+) and negative (-) sides correctly oriented as indicated on the remote control.
- Keep batteries out of reach of children and pets.
- Remove the battery, if the remote control is not used for a long time.
- Do not combine a new battery with an old one.
- Do not try to recharge batteries. Do not use rechargeable batteries.
- If the solution of batteries comes in contact with your skin or clothes, rinse with water. If the solution comes in contact with your eyes, rinse them with water and then consult your doctor.

LABEL LOCATIONS

CAUTION Label

	CAUTION Do not touch the power supply capacitor. It may be charged even after the power is turned off. To avoid electric shock, wait for 5 minutes after the power is turned off before touching the capacitor.	VORSICHT Vor dem Berühren des Netzteils warten Sie 5 Minuten, nachdem Sie die Stromversorgung unterbrochen haben.	ATTENZIONE Non toccare il condensatore dell'alimentazione. Anche dopo aver spento il proiettore, il condensatore può rimanere carico. Per evitare scosse elettriche, attendere 5 minuti dopo aver spento il proiettore prima di toccare il condensatore.	ATTENTION Do not touch the power supply capacitor. It may be charged even after the power is turned off. To avoid electric shock, wait for 5 minutes after the power is turned off before touching the capacitor.	PRECAUCIÓN No toque el condensador de la fuente de alimentación. Incluso después de haber apagado el proyector, el condensador puede seguir cargado. Para evitar recibir una descarga eléctrica, espere 5 minutos después de haber apagado el proyector antes de tocar el condensador.
---	---	---	--	---	--

MODEL NO. / RATING Label

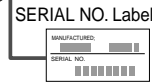
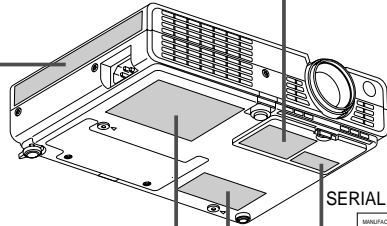
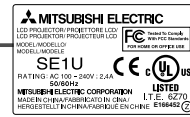

CAUTION Label

CAUTION Do not operate before opening the fuse cover. Do not replace the fuse cover until you have read the instructions on the fuse cover. Always use the correct fuse.	CAUTION Do not touch the power supply capacitor. It may be charged even after the power is turned off. To avoid electric shock, wait for 5 minutes after the power is turned off before touching the capacitor.
VORSICHT Vor dem Öffnen des Sicherungsdeckels dürfen Sie nicht an der Sicherung arbeiten. Lesen Sie die Anweisungen zum Ersetzen der Sicherung. Verwenden Sie immer die richtige Sicherung.	VORSICHT Vor dem Berühren des Netzteils warten Sie 5 Minuten, nachdem Sie die Stromversorgung unterbrochen haben.
ATTENZIONE Non operare prima di aprire il coperchio della scatola fusibili. Leggere attentamente le istruzioni per il cambio della lampadina. Usare sempre il tipo di lampadina corretto.	ATTENZIONE Non toccare il condensatore dell'alimentazione. Anche dopo aver spento il proiettore, il condensatore può rimanere carico. Per evitare scosse elettriche, attendere 5 minuti dopo aver spento il proiettore prima di toccare il condensatore.
ATTENTION Do not operate before opening the fuse cover. Do not replace the fuse cover until you have read the instructions on the fuse cover. Always use the correct fuse.	ATTENTION Do not touch the power supply capacitor. It may be charged even after the power is turned off. To avoid electric shock, wait for 5 minutes after the power is turned off before touching the capacitor.
PRECAUCIÓN No opere antes de abrir la tapa de la caja de fusibles. Lea atentamente las instrucciones para el cambio de la lámpara. Siempre use el tipo de lámpara correcto.	PRECAUCIÓN No toque el condensador de la fuente de alimentación. Incluso después de haber apagado el proyector, el condensador puede seguir cargado. Para evitar recibir una descarga eléctrica, espere 5 minutos después de haber apagado el proyector antes de tocar el condensador.

CAUTION Label

	注意 電源開閉後も電源コンデンサが充電されている場合があります。電源を切った後、5分程度待ってから電源コンデンサに触ると感電の恐れがあります。	ATTENZIONE L'apertura del coperchio della scatola fusibili deve essere preceduta dalla lettura delle istruzioni per il cambio della lampadina. Usare sempre il tipo di lampadina corretto.
CAUTION Do not operate before opening the fuse cover. Do not replace the fuse cover until you have read the instructions on the fuse cover. Always use the correct fuse.	VORSICHT Vor dem Öffnen des Sicherungsdeckels dürfen Sie nicht an der Sicherung arbeiten. Lesen Sie die Anweisungen zum Ersetzen der Sicherung. Verwenden Sie immer die richtige Sicherung.	PRECAUCIÓN No opere antes de abrir la tapa de la caja de fusibles. Lea atentamente las instrucciones para el cambio de la lámpara. Siempre use el tipo de lámpara correcto.

CAUTION Label

	CAUTION Do not look into the air outlet while the projector is operating.	ATTENTION Do not regard the air outlet as a source of heat during operation.
VORSICHT Schauen Sie nicht durch die Luftauslassung während des Betriebs.	PRECAUCIÓN No mire a través de la salida de aire durante el funcionamiento.	

WARNING Label

	警告 電源プラグを抜き、電源ケーブルを接続するときは必ず電源スイッチをオフにしてください。
---	---

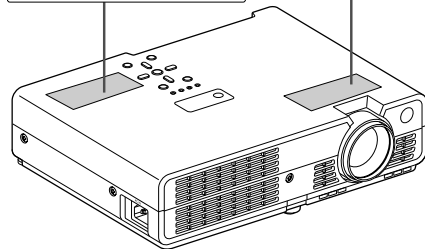

POWER SUPPLY CORD SELECTION

If your line voltage is 220 to 240V, use one of the following types of cable.

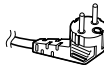
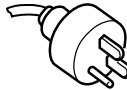
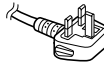
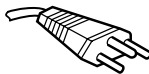
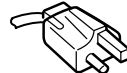
Plug configuration	Plug type	Line voltage	Plug configuration	Plug type	Line voltage
	EURO	220 – 240V		Australian 240V 10A	200 – 240V
	UK	220 – 240V		Switzerland 240V 6A	200 – 240V
				North American 240V 15A	200 – 240V

Use a 5A fuse which is approved by ASTA or BSI to BS1362. Always replace the fuse cover after changing the fuse.

IMPORTANT PRECAUTIONS

Moisture Condensation

Never operate this unit immediately after moving it from a cold location to a warm location. When the unit is exposed to such a change in temperature, moisture may condense on the crucial internal parts. To prevent the unit from possible damage, do not use the unit for at least 2 hours when there is an extreme or sudden change in temperature.

Place and Manner of Installation

- Do not place in hot locations, such as near heating equipment. Doing so could cause malfunction, and shorten the life of the LCD panel.
- Avoid locations with oil or cigarette smoke. Doing so will dirty the LCD panel and other optical parts, shortening their lives, and darkening the screen.
- Using this instrument near a TV or radio may cause interference to the images or audio sound. If this happens, move it away from the TV or radio.
- Moving the projector from a low-temperature room to a high-temperature room may cause condensation on the lens or internal parts in the instrument. If you continue to use it in that situation, the malfunction may result. Ensure to wait until the condensation naturally disappears.
- In a high altitude location where air is thin, cooling efficiency of the scanner is reduced so use it with the ambient temperature being lowered.

Before Using

IMPORTANT PRECAUTIONS (Continued)

Avoid Volatile Liquid

Do not use volatile liquids, such as an insect spray, near the unit. Do not leave rubber or plastic products touching the unit for a long time. They will leave marks on the finish. If cleaning with a chemically saturated cloth, be sure to follow the product's precautions.

LCD Panel

The life of the LCD panel is limited. Take care over the points below so as to use the panel for years.

- To prolong the life of this panel, never fail to turn the power off when the panel is not in use and make sure that the lamp has gone out. The state of the lamp being extinguished helps enhance the effect of energy saving.
- If the air filter is stained and is clogged up, the main unit inner temperature rises. As a result, the life of the LCD is shortened and a malfunction may also occur. Clean the air filter from time to time and replace it regularly. It is recommended that this replacement be done at the time of replacing a lamp. (Ask a dealer where the unit was purchased or your nearby service station about an air filter for replacement.)

In the spaces provided below, record the Model and Serial No. located at the bottom of your LCD projector.

Model No. _____ Serial No. _____

Retain this information for future reference.

Declaration of Conformity

Model Number : SE1U
Trade Name : MITSUBISHI ELECTRIC
Responsible party : Mitsubishi Digital Electronics America, Inc.
9351 Jeronimo Road, Irvine, CA 92618 U.S.A
Telephone number : +1-(949) 465-6000

This device complies with Part 15 of the FCC Rules. Operation is subject to the following two conditions:

- (1) this device may not cause harmful interference, and
- (2) this device must accept any interference received, including interference that may cause undesired operation.

EXEMPTION CLAUSES

- Mitsubishi Corporation bears no responsibility in the case of damages arising from natural disaster such as earthquakes, lightning, etc., fire not liable to Mitsubishi Corporation, operating by third parties, other accidents, or use under abnormal conditions including erroneous or improper operation and other problems.
- Mitsubishi Corporation bears no responsibility for incidental damages (lost profit, work interruption, corruption or loss of the memory contents, etc.) arising from the use of or the inability to use this unit.
- Mitsubishi Corporation accepts no liability whatsoever for any damages arising from not having followed the descriptions in this User Manual.
- Mitsubishi Corporation accepts no liability whatsoever for any damages arising from malfunctions arising from combination with equipment or software that is not related to Mitsubishi Corporation.

OTHER CAUTIONS AND INFORMATIONS

Copyrights

Showing or transmitting commercial imaging software or broadcast or cable-broad casting programs with the purpose of other than the personal and private viewing, including modifying images using the still or expand functions, or displaying with the varying aspect ratio of the images, could violate the direct or indirect copyrights of the imaging software or broadcast program, etc., if done without first consulting with the copyright holder. For this reason, please take appropriate measures before performing one of the actions listed above, including obtaining a license from the copyright holder.

Disposal

This product contains substances which are harmful to humans and the environment.

- Solder used in the internal parts contains the lead.
- The lamp contains inorganic mercury.

Please dispose of this product or used lamps in accordance with local regulations.

Trademarks

- VGA, SVGA, XGA, SXGA, UXGA are trademarks or registered trademarks of International Business Machines Corporation.
- Macintosh is a registered trademark of Apple Computer, Inc.
- Windows is a registered trademark of Microsoft Corporation in the U.S. and other countries.
- Adobe is a registered trademark and Acrobat Reader is a trademark of Adobe Systems Incorporated.

Notational Conventions Used in This Manual

References to pages with related information are annotated as follows.

For example, if making a reference to page 24: [p.24](#)

CONTENTS

Before Using

IMPORTANT SAFEGUARDS	3
ABOUT LAMP	7
ABOUT REMOTE BATTERIES	7
LABEL LOCATIONS	8
POWER SUPPLY CORD SELECTION	9
IMPORTANT PRECAUTIONS	9
EXEMPTION CLAUSES	11
OTHER CAUTIONS AND INFORMATIONS	11
CONTENTS	12

Preparations

Checking the package contents	14
Names of each part on the main unit	15
Names of each part on the control panel and remote control	16
Preparing and using the remote control	17
Placement	18
Connection	19

Operations

Turning the power on and off	20
Basic operations	22
Using handy features	24
Using auto positioning (Auto Positioning)	24
Correcting the keystone distortion (Keystone)	25
Zooming out the images	25
Cutting off the picture and sound temporarily (Mute)	26
Still the image (Still)	26
Expanding the picture size (Expand)	27
Displaying Information [Status display]	28
Using the menus	29
How to use the menus	29
The image adjustment menu	30
The default setting menu	30
The display setting menu	31
Reset menu (Special menu)	31

Maintenance

Air filter cleaning	32
Lens and main unit cleaning	33
Lamp replacement	33

Others

Trouble indications	35
Before calling service personnel	36
Specifications	37
List of general specifications	37
Separately Sold Product	37
List of supported signals (RGB signals)	38
List of supported signals (Y/Pb/Pr signals)	39
List of supported signals (Video, S-Video signals)	39
Pin assignment of COMPUTER & COMPUTER OUT terminals	39
SERIAL terminal	40

Checking the package contents

Please make sure that the following items are included in the box, along with the main unit. If any item is missing, please contact the store immediately where you purchased the product.

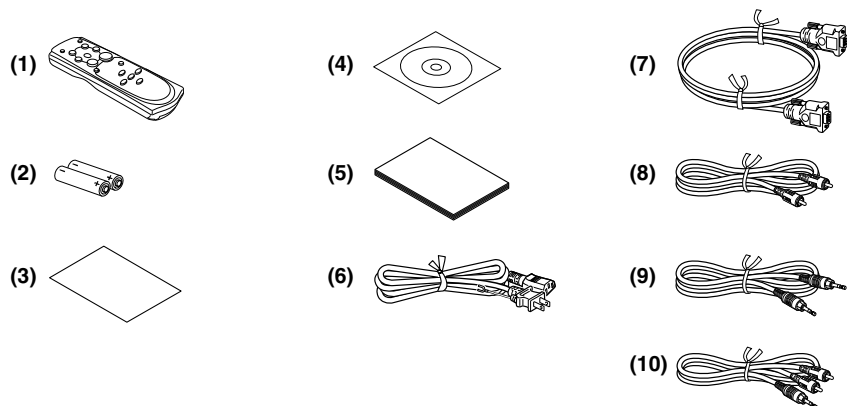

- (1) Remote control
- (2) R03 (SIZE AAA) batteries for remote control (2)
- (3) Quick Reference Card
- (4) CD-ROM
- (5) User Manual
- (6) AC power cord (See note)
- (7) RGB cable (for PC) (23368818)
- (8) Video cable (23368800)
- (9) Audio cable (for PC) (23368799)
- (10) Audio cable (for a VCR) (23368798)

Note

The shape and number of supplied power cords vary depending on the product destination.

◆The Supplied CD-ROM

The supplied CD-ROM contains a user manual, including information omitted in the User Manual (Getting started) and Acrobat® Reader™ to view the manual.

■ Installing Acrobat® Reader™

Windows®: Run the CD-ROM, select the **Reader/English** folder, and run **ar500enu.exe**.

Follow the on-screen instructions.

Macintosh: Run the CD-ROM, select the **Reader/English** folder, and run **Reader Installer**. Follow the on-screen instructions to install the software.

■ Viewing the manual

Run the CD-ROM and double-click on **Start.pdf**. Acrobat® Reader™ launches, and the menu screen of the User Manual appears. Click on your language. The User Manual cover and list of bookmarks appear. Click on a bookmark title to view that section of the manual. Click on [p. 16](#) to view a reference page with related information. See the Help menu for more information about Acrobat® Reader™.

Names of each part on the main unit

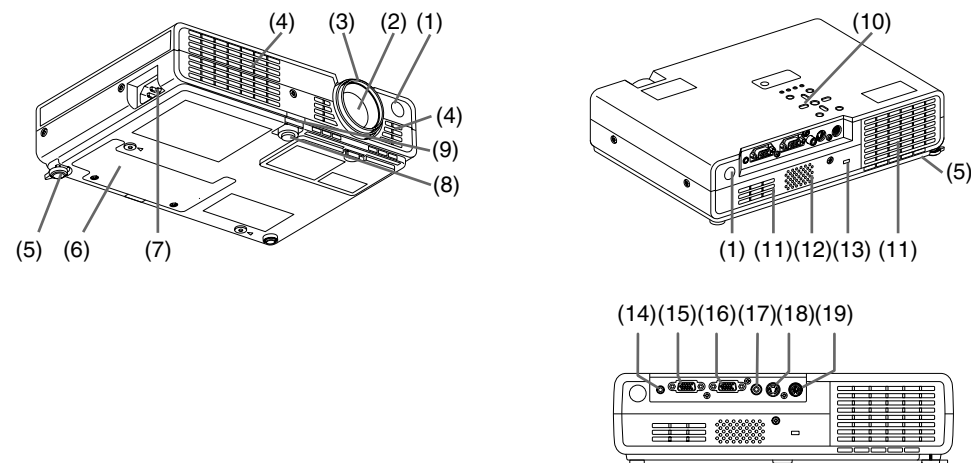

Name	Function
(1) Infrared remote sensor	: Senses commands from the remote control. p.17
(2) Lens	: Projects expanded image.
(3) Focusing ring	: Adjusts screen focus. p.23
(4) Air intake	: Draws in air from outside unit.
(5) Tilt adjuster	: Adjusts the projector's horizontal tilt. p.23
(6) Lamp cover	: Remove to replace lamp. p.34
(7) AC IN socket	: Connect the supplied AC power cord here. p.20
(8) Foot adjuster	: Adjusts the vertical projection angle. p.23
(9) Foot adjuster release button	: Press to stow the foot adjuster. p.23
(10) Control panel	: Operates the projector. p.16
(11) Air exhaust	: Expels air that has grown hot inside the projector.
(12) Speaker	: Plays audio.
(13) Anti-theft lock hole	: Attach a security chain, etc. here.
(14) AUDIO terminal	: Feeds the audio signal from a computer or video equipment.
(15) COMPUTER OUT terminal	: Connected to the monitor display.
(16) COMPUTER terminal	: Feeds the RGB signal from a computer or the component video signal (Y/Pb/Pr) from a video equipment.
(17) VIDEO terminal	: Feeds the video signal from a video equipment.
(18) S-VIDEO terminal	: Feeds the S-video signal from a video equipment.
(19) SERIAL terminal	: Connected to the RS-232C port on a controlling computer for operating the projector. p.40

Names of each part on the control panel and remote control

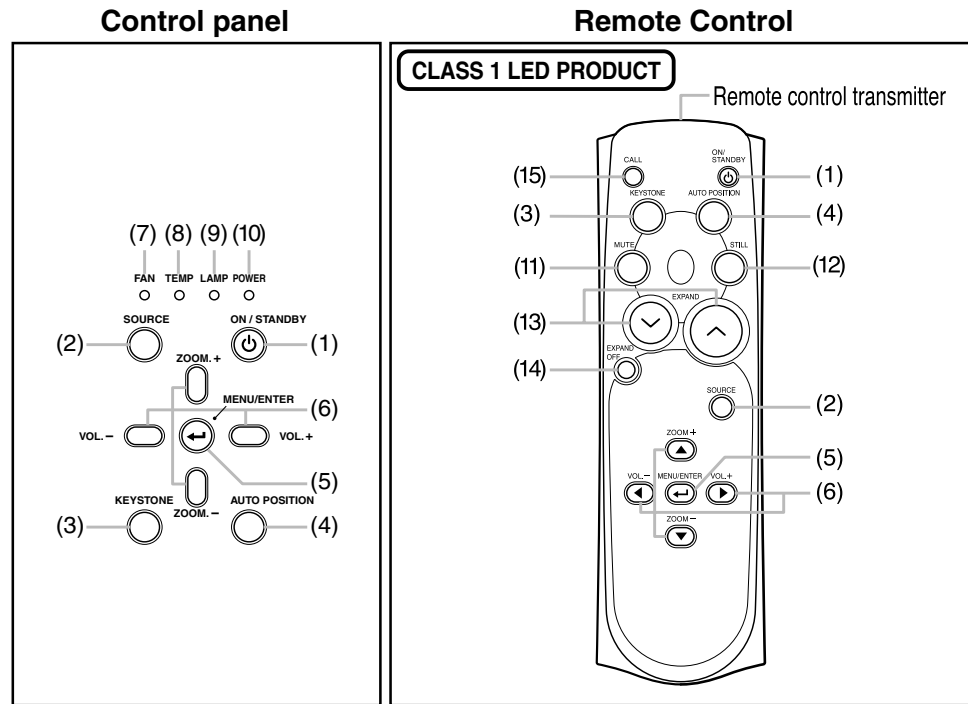

Name	Main Function
(1) ON/STANDBY button	: Turns the power on/off (standby). p.20
(2) SOURCE button	: Selects source. p.22
(3) KEYSTONE button	: Adjusts keystone (trapezoidal distortion). p.25
(4) AUTO POSITION button	: Sets up image and mode. p.24
(5) MENU/ENTER button	: Displays menus and makes selections. p.29
(6) Selection buttons	: Menu selections and adjustments, etc. p.29
(7) FAN indicator	: Displays cooling fan mode. p.23 p.35
(8) TEMP indicator	: Lights when internal temperature too high. p.35
(9) LAMP indicator	: Displays lamp mode. p.21
(10) POWER indicator	: Displays whether power is on or off. p.20
(11) MUTE button	: Cuts off the picture and sound temporarily. p.26
(12) STILL button	: Pauses image. p.26
(13) EXPAND buttons	: Enlarge picture size. p.27
(14) EXPAND OFF button	: Exiting the operation. p.28
(15) CALL button	: Displays the information on the screen. p.28

Note

- For the remainder of this manual, buttons are referred to as follows:
 Selection buttons ⇒ ; MENU/ENTER button ⇒

Preparing and using the remote control

Loading dry-cell batteries into the remote control

- Remove the battery cover.

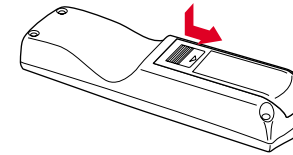

- Insert the dry-cell batteries.

Load the batteries making sure that they are positioned correctly (+ to +, and - to -). Load the batteries from - spring side, and make sure to set them tightly.

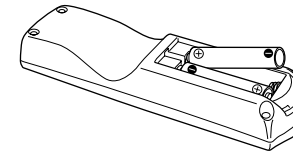

Two batteries (R03, SIZE AAA) are used.

- Replace the battery cover.

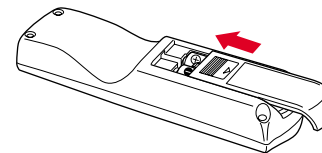

Dry-cell batteries

- Before using the batteries, be sure to observe the ABOUT REMOTE BATTERIES described in previous pages.
- Remove batteries from remote control when not using for extended periods.
- If the remote control stops working, or if its range decreases, replace all the batteries with new ones.

The remote control

- The remote control may fail to operate if the infrared remote sensor is exposed to bright sunlight or fluorescent lighting.
- Do not drop or bang.
- Do not leave in hot or humid locations.
- Do not get wet or place on top of wet objects.
- Do not take apart.
- In rare cases, ambient conditions could impede the operation of the remote control. If this happens, point the remote control at the main unit again, and repeat the operation.

Operating the remote control

Point the remote control toward the projector's infrared remote sensor, and press a button on the remote control.

- Operating the projector from the front

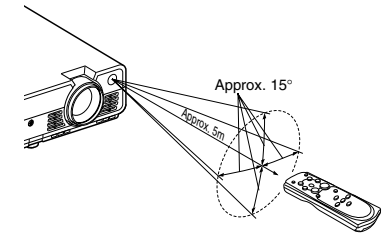

- Operating the projector from the rear

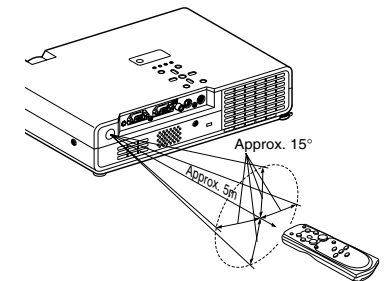

Placement

Placement Styles

As shown in the figures below, this device can be placed in 4 different styles. The factory setting is "floor-mounted front projection." Set the **placement style** in the **default setting menu** [p.30](#), in accordance with your needs.

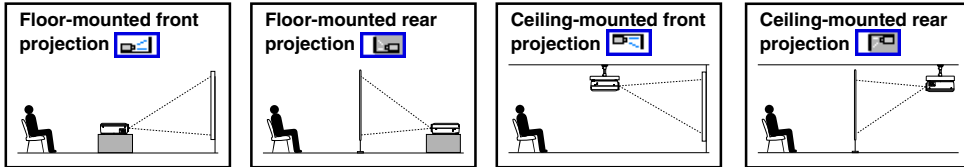

CAUTION

- Always obey the instructions listed in IMPORTANT SAFEGUARDS when placing the unit.
- If you wish to mount the projector on the ceiling, be sure to ask your dealer to do so. Mounting the projector on a ceiling requires special ceiling brackets and specialized knowledge. Improper mounting could cause the projector to fall, resulting in an accident.
- If the projector is ceiling-mounted, install the breaker for turning off the power in case of anomaly. Let everyone involved with the use of the projector know that fact.

Projection Distance and Screen Size

Use the figures and table below to determine the screen size and projection distance. (Screen sizes are approximate values for full-size picture with no keystone adjustment)

As seen from above

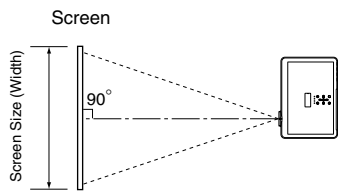

As seen from the side

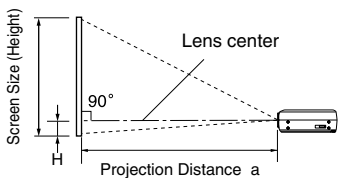

● Values listed below may differ from actual values.

Screen Size			Projection Distance(a)	Height
(Inch)	Width(cm)	Height(cm)	(m)	(cm)
40	81	61	1.5	6.1
60	122	91	2.3	9.1
80	163	122	3.1	12.2
100	203	152	3.8	15.2
150	305	229	5.8	22.9
200	406	305	7.7	30.5
250	508	381	9.7	38.1
300	610	457	11.6	45.7

a is the distance (m) between the lens and the screen, and corresponds to a range of 1.5 m to 11.6 m.

Connection

Before connection

- Read the user manual of the device to connect to the projector.
- Some types of computer cannot be used or connected to this projector. Check for an RGB output terminal, supported signal [p.38](#), etc.
- Turn off the power of both devices before connecting.
- The figure below is a sample connection. This does not mean that all of these devices can or must be connected simultaneously. (Dotted lines mean items can be exchanged.)

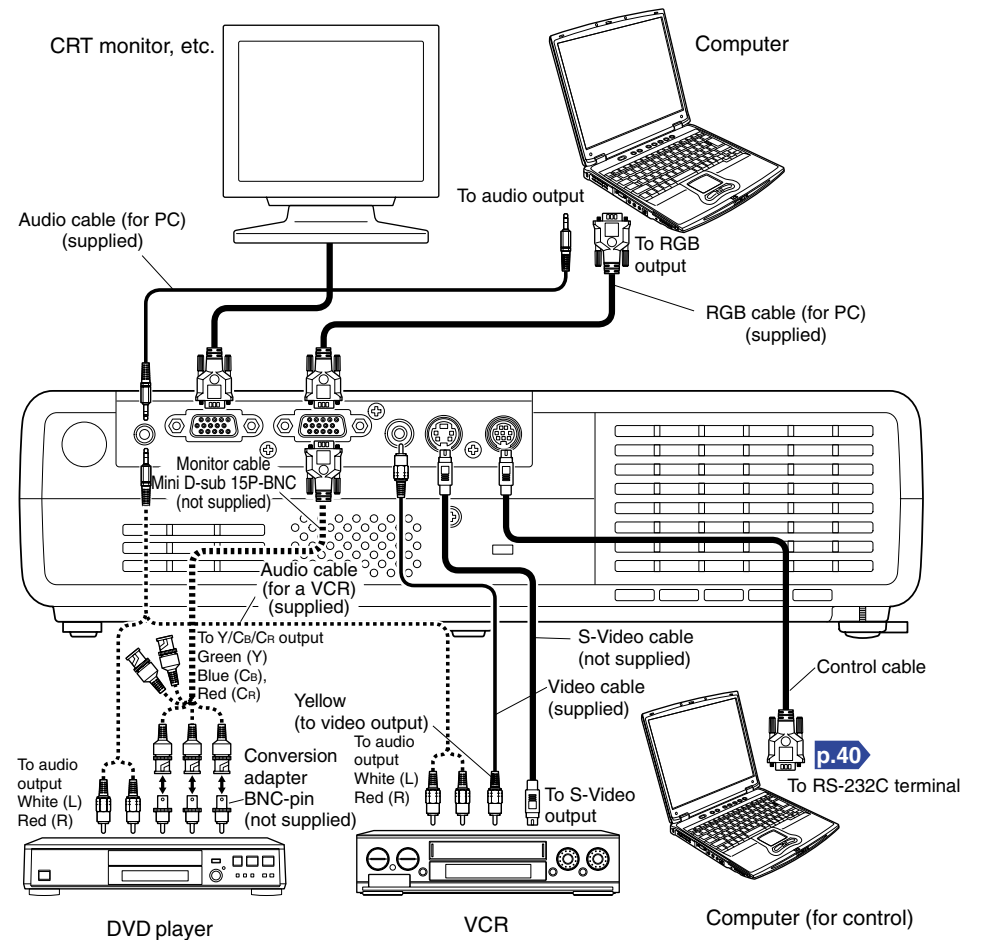

Note

- The AUDIO terminal can be used with all the devices for input (source) terminal.

Turning the power on and off

■ Connecting the AC power cord

- 1 Insert the AC power cord connector into the AC IN socket of the projector.
- 2 Insert the AC power cord plug into a wall or other power outlet.

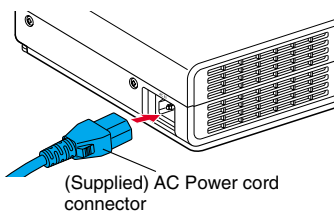

When the power cord is plugged in, the following three green indicators will come on for several seconds: POWER, TEMP, and LAMP. Next, the POWER indicator will change to orange, indicating standby mode. (Do not perform any operations while the 3 green indicators are on.)

Removing the lens cover

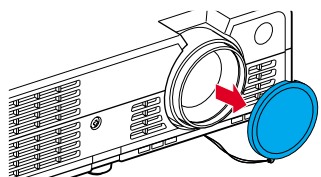

Be sure to remove the lens cover when the power is turned on. If it is left on, it could become deformed due to heat.

■ Turning the power on

- 1 Press the ON/STANDBY button.

The power turns on, and the following 3 green indicators light: POWER, LAMP, and FAN. After a moment, the start-up screen appears.

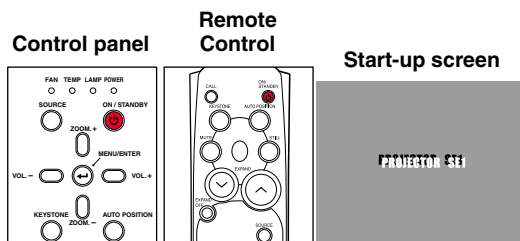

⚠ WARNING

- Do not look into the lens during operation. Doing so could damage your vision.

⚠ CAUTION

- Do not block the air intake or exhaust. Doing so could cause a fire due to internal overheating.
- Do not place your hands, face, or other objects near the air exhaust. Doing so could cause burns, deform/break the object.

■ Notes

- The start-up screen will disappear after a moment. You can dismiss the start-up screen before this by performing any operation. You can also configure the start-up screen not to appear via the **Display setting menu** [p.31](#).
- The first time you use the projector after purchase, after the start-up screen disappears, the Language menu is displayed [p.22](#).

■ Turning the power off

- 1 Press the ON/STANDBY button.

A message appears on the screen, confirming that you wish to shut off the power. This message will disappear after a moment. (This operation is no longer valid after the message disappears.)

- 2 Press the ON/STANDBY button again.

The screen turns off, but the internal cooling fan continues to operate for a short while. Then, the projector goes into standby mode.

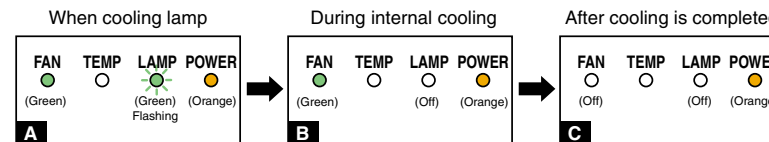

- A During cooling, the LAMP indicator flashes. In this state, the power cannot be turned back on. In addition, unplugging the power cord in this state will shorten the life of the lamp.
- B After the LAMP indicator goes off, the cooling fan continues to operate for a short while in order to expel excess internal heat.
- C In standby mode.

■ Note

- The projector consumes about 6W of power in standby. We recommend you to unplug the AC power cord if you will not use the projector for an extended period.

■ PRECAUTIONS

- Before unplugging the AC power cord, make sure that the LAMP indicator is off. Unplugging the AC power cord and cutting off the power while the projector is running or being cooled will shorten the life of the lamp. **However, please unplug the AC power cord if the projector locks up or acts abnormally.**
- If the AC power cord was unplugged before cooling was complete, give the lamp sufficient time to cool before plugging it back in. If the lamp overheats, it may fail to light, and its lifetime will be shortened.

■ LCD Panels

LCD panels wear out. In order to prolong the lifetime of your LCD panel, take the following precautions.

- In order to extend the lifetime of the LCD panel, always turn off the power when not in use, and make sure that the lamp is off. Keeping the lamp off is also very effective at saving electricity.
- If the air filter becomes dirty and clogged, the projector's internal temperature will rise, shortening the lifetime of the LCD panel and causing malfunctions. Clean the air filter from time to time [p.32](#), and replace it periodically. Contact the store where you purchased your projector, or your local Service Station for replacement air filters.

Basic operations

1 Turn on the power.

Turn on the power by following the instructions in “Turning on the power” [p.20](#).

2 Select the language and the lamp power (When using the first time).

When the projector is used for the first time after purchase, menu for language and lamp power selection and configuration is displayed in English. (If the screen is out of focus, adjust it according to the step 6.)

1 Use the ▲ or ▼ buttons to select the desired language and press the ⏻ button.

Message for setup confirmation is displayed in a selected language.

2 Using the ▲ or ▼ button, select Standard or Low and press the ⏻ button.

The lamp power, if selected, will be toggled without pressing the ⏻ button. The display automatically disappears in a few seconds.

English	English
Français	French
Deutsch	German
Italiano	Italian
Español	Spanish
Português	Portuguese
日本語	Japanese
中文(简体字)	Chinese (simplified)
中文(繁體字)	Chinese (traditional)
한국어	Korean

Notes

- When the projector is turned on the next time, the Language and Lamp power menus do not appear upon startup. However, if “Reset all” is executed from the **Reset** menu [p.31](#), the Language and Lamp power menus will be displayed the next time when the power is turned on.
- The language can also be set via the Display setting menu [p.30](#) and Lamp power via the Default setting menu [p.30](#).
- This user manual assumes that English has been selected.

3 Place connected device(s) in operating status.

Turn on and boot up connected computers and other devices.

4 Select source.

1 Press the SOURCE button.

A list of sources appears on the screen.

2 Use the ▲ ▼ buttons to select the desired source, and press the ⏻ button.

The picture for the selected source is projected.

Computer
Y/Pb/Pr
Video
S-video

5 Projector placement angle adjustments

The placement angle and the height of the projected image can be adjusted by the foot adjuster.

1 Lift up the front of the projector to the desired angle, then press the foot adjuster release button.

The foot adjuster extends. Release the button to lock the position.

2 Turn the foot adjuster to fine-tune the angle.

3 To adjust the horizontal angle, use the tilt adjuster.

To stow the foot adjuster, hold up the projector while pressing the foot adjuster release button, then slowly lower the projector.

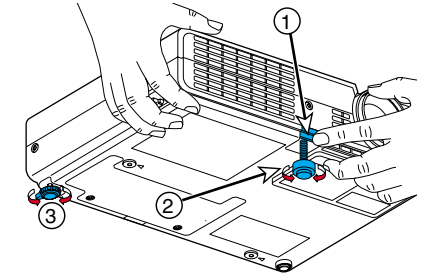

6 Adjust the picture size and focus.

1 Move the projector back and forth to adjust the screen size.

2 Use the focusing ring to adjust the focus.

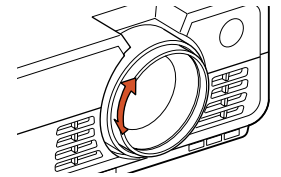

7 Adjusting the volume with the ◀ ▶ buttons

The speaker volume can be adjusted when an audio signal is being input.

Notes

- Note that because of the lamp characteristics, the brightness of the lamp may fluctuate slightly.
- A lamp is a consumable supply. If used for extended periods, images will appear dark, and the lamp could burn out. This is characteristic of a lamp, and is not malfunction. (The lifetime of the lamp depends on conditions of use.)
- The LCD panel is made using extremely advanced technology, but there may be black spots (pixels that do not light) or bright spots (pixels that are constantly lit) on the panel. Please note that these are not malfunctions.
- Although this projector supports a wide range of RGB signals [p.38](#), any resolutions not supported by the model (XGA or SVGA, depending on the model) will expand or shrink the pictures, and will affect image quality slightly. To view high-quality images, it is recommended that the computer's external output should be set to the projector's resolution.
- With some models of computer having LCD displays or the like, displaying images simultaneously on the projector and the monitor's display may cause the images to be shown improperly. If this happens, turn off the computer's LCD display. For information on how to turn off the LCD display, see the owner's manual of your computer.
- If a signal not supported by the projector is input, the icon will appear.
- If a no signal is being input from the connected device, the icon will appear.
- If an unavailable operation button is pressed, the icon will appear.

Using handy features

■ Using auto positioning (Auto Positioning)

This function sets up the projector to the optimum state for each type of the input signal by using simple operations.

① Press the AUTO POSITION button.

The Auto positioning menu appears.

② Press the AUTO POSITION button again.



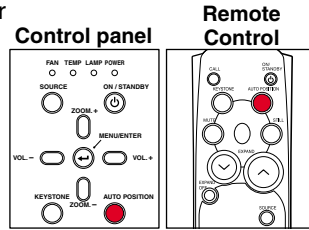



The menu item is automatically adjusted/positioned. For computer input, the  icon will appear during processing.

































■ Note

- Auto adjustment/positioning may not be performed correctly for source signals other than those supported by the projector [p.38](#) , [p.39](#) .

● Manual adjustment and positioning

The menu items vary depending on the source type, as shown in the table below. Use the      buttons to adjust the items in the table below, then press the  button when you are finished. The menu disappears. (The EXPAND OFF button on the remote control also allows you to exit the menu mode.)

Source	Item	Description
Computer	 Phase	Adjust with   to eliminate flicker.
	 Frequency	Adjust with   to eliminate periodic patterns and flickering when many vertical lines appear on the screen.
	 H-position	Move left  Move right 
	 V-position	Move down  Move up 
	 Clamp 1	Adjusts the clamp pulse position with  or  .
	 Clamp 2	Adjusts the clamp pulse width with  or  .
Y/Pb/Pr	 Phase	Adjust with   to eliminate flicker.
	 Signal format	[]: Enter to setting mode]→[ ]: Select one of the following]→[Apply: ] 480i(525i)@60Hz/480p(525p)@60Hz/ 576i(625i)@50Hz/576p(625p)@50Hz/ 720p(750p)@60Hz/720p(750p)@50Hz/ 1080i(1125i)@60Hz/1080i(1125i)@50Hz/ 1035i(1125i)@60Hz/1152i(1250i)@50Hz
Video S-video	 Video mode	[]: Enter to setting mode]→[ ]: Select one of the followings]→[Apply: ] NTSC/PAL/SECAM/PAL-N/PAL-M/PAL60/NTSC4.43

■ Note

- Moving pictures generated with the DVD software for computers may appear unnatural if it is projected with this projector, but it is not a malfunction.

■ Correcting the keystone distortion (Keystone)

When the foot adjuster [p.23](#) is used to change the projection angle, the picture will undergo keystone (trapezoidal) distortion. This projector is capable of correcting this keystone distortion.

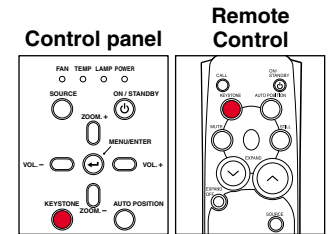
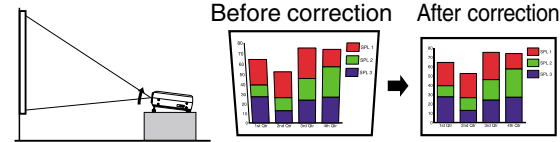





① Press the KEystone button.

The Keystone menu appears.

② Use the buttons for keystone adjustment.

On completing the adjustment, press the  button to dismiss the menu (you can also use the EXPAND OFF button on the remote control for menu dismissal).

Item	Description
 Keystone	Shrink bottom of the screen   Shrink top of the screen  

■ Notes

- Depending on the amount of keystone adjustment and the content of images, some information may be lost, or the picture quality may suffer.
- Keystone adjustment will not change the shape of the menus.

■ Zooming out the images

This equipment is provided with the digital zoom (electric zoom: 100-80%). (Note that the display, if digitally zoomed out, may suffer from some degradation.)

① Press the ZOOM – button.

Each time the ZOOM – button is pressed, the image is reduced in size.

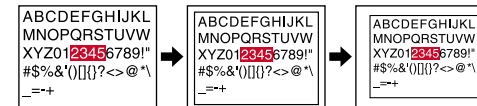

② Press the ZOOM + button to bring it back to the original size.

Each time the ZOOM + button is pressed, the image size increases. (You cannot make it larger than the original size.)

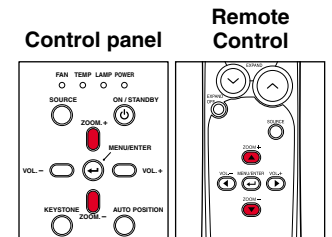
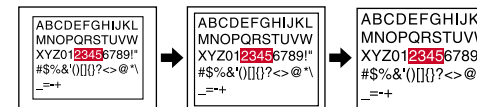

■ Notes

- Pressing either the ZOOM– or ZOOM+ button would display the  icon.
- The adjustment value will automatically be saved.

Using handy features (Continued)

■ Cutting off the picture and sound temporarily (Mute)

When you want to project the images of another projector, overhead projector, etc. temporarily, this projector's images and sound can be turned off.

● Press the remote control's MUTE button.

The picture and sound are cut off. The Mute function is released when pressing the MUTE button again. To cancel the command, press the EXPAND OFF button.

■ Notes

- The  icon will appear while mute is in effect.
- Operating any other functions cancel the muting.

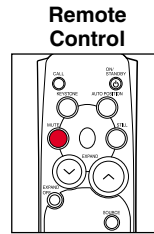

■ Still the image (Still)

The image being projected can be made to be frozen. This function is to be used to pause a video during a presentation, etc.

● Press the remote control's STILL button.

The picture pauses. The Still function is released when pressing the STILL button again. To cancel the command, press the EXPAND OFF button.

■ Notes

- The  icon will appear while still is in effect.
- The still function can be used on the Expand function. Other operations will release the still.
- Even if an image is frozen on the projector, the pictures are running on the video or other equipment.
- If you use this function on video soft sold on the market, broadcast or broadcast on cable except for the purpose of your private viewing and listening, it may infringe the copyright protected by the copyright laws.

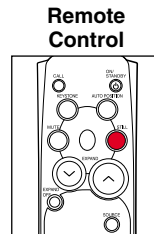

■ Expanding the picture size (Expand)

The image being projected can be expanded.

① Press the remote control's EXPAND button.

The expanding ratio is increased each time the EXPAND  button is pressed.

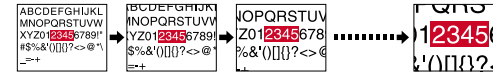

② To decrease the expanding ratio, press the remote control's EXPAND button.

The expanding ratio is decreased each time the EXPAND  button is pressed. (The image cannot be shrunk to less than its original size.)

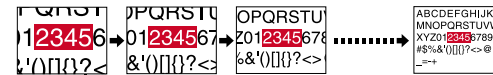

③ Press and hold down the buttons to move the expanded area.

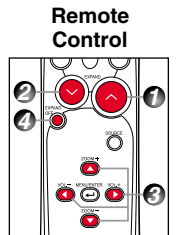
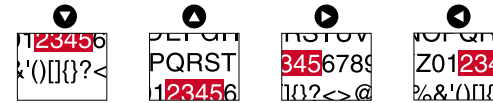

④ Press the EXPAND OFF button to undo the expanding.

The expanding is released, and the image returns to its original size.

■ Notes

- The  icon will appear while expand is in effect.
- An expanded image can be frozen using the STILL button. The expand function on a frozen image can also be used.
- Operations other than still will cancel the expand.
- Since the expanding is performed using digital processing, expanding will cause the image to appear jagged.
- Rarely, the picture could become garbled while the expanded area is being moved.
- If you use this function on video soft sold on the market, broadcast or broadcast on cable except for the purpose of your private viewing and listening, it may infringe the copyright protected by the copyright laws.

Using handy features (Continued)

■ Displaying Information [Status display]

This displays information about the input signal, lamp use time, etc.

- Press the button twice (or press the CALL button on the remote control once).

When the button is pressed once, the **Setting display menu** appears. Pressing it again displays information [p.29](#). The table below shows what kind of information is displayed. Press the button (or press the CALL or EXPAND OFF button on the remote control to serve the same purpose) again to dismiss the display.

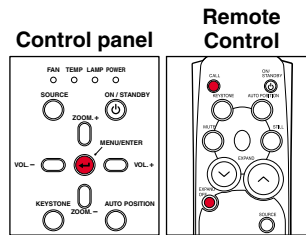

“Yes”: displayed, “No”: not displayed

Item	Description	Computer	Y/Pb/Pr	Video	S-video
Source	Input source name	Yes	Yes	Yes	Yes
RGB signal mode	RGB input mode ^[Note 1]	Yes	No	No	No
H-resolution	Horizontal resolution (in bits)	Yes	No	No	No
V-resolution	Vertical resolution (in bits)	Yes	No	No	No
H-frequency	Horizontal sync frequency	Yes	No	No	No
V-frequency	Vertical sync frequency ^[Note 2]	Yes	No	No	No
Sync	Sync signal polarity ^[Note 3]	Yes	No	No	No
Signal format	Y/Pb/Pr signal format	No	Yes	No	No
Video mode	Color method of video signal	No	No	Yes	Yes
Lamp time	Time of lamp use ^[Note 4]	Yes	Yes	Yes	Yes
Version	Firmware version ^[Note 5]	Yes	Yes	Yes	Yes

Notes

- 1: The mode of supported RGB signals [p.38](#) is shown.
- 2: Same as the refresh rate of the computer signal.
- 3: Sync signal polarity shown as P (positive) or N (negative) for [H/V].
- 4: Displays [Lamp time] as a measure of when the lamp should be replaced. (Cannot be used as a counter of guaranteed lamp time.) When the displayed time approaches 2,000 hours, consult with a store about getting aVLT-SE1LP replacement lamp (sold separately) prepared.
- 5: [Version] shows the version of the projector's internal control program. This version is referred to for customer service, etc.

■ Notes

- The displayed information will not be refreshed if the status changes. To refresh the information, dismiss the display, then display it again.
- Conducting another operation while information is being displayed dismisses the display.

Using the menus

You can call up on-screen menus, and conduct a number of adjustments and settings using the operation buttons [p.16](#) on the control panel (main unit side) and remote control.

■ How to use the menus

The menu shown below is only for operation instructions and might be different from the actual display.

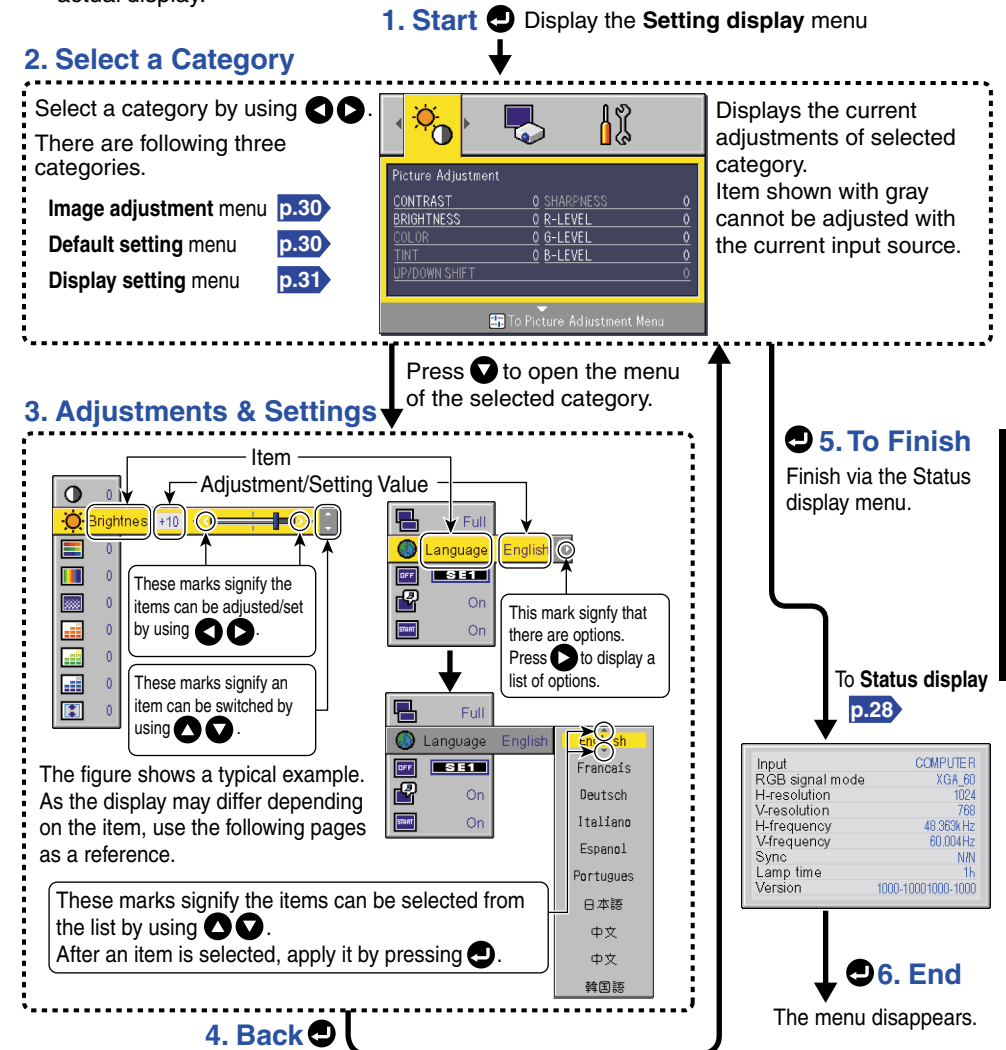

■ Notes

- Menu adjustments and settings are saved when the power is turned off via the **ON/STANDBY** button. If the AC power cable is disconnected before this, or the power goes out, then the data will not be saved.
- You can also use the **EXPAND OFF** button on the remote control to dismiss the menu display.

Using the menu (Continued)

■ The image adjustment menu

Use this menu to adjust image-related items.

Items that can be adjusted are marked with “Yes”, and those that cannot are marked with “No”.

Item ▲▼	Description	Computer	Y/P _B /P _R	Video	S-video
Contrast	Lower ◀▶ Higher	Yes	Yes	Yes	Yes
Brightness	Darker ◀▶ Brighter	Yes	Yes	Yes	Yes
Color	Lighter ◀▶ Deeper	No	Yes	Yes	Yes
Tint ^[Note 1]	Reddish ◀▶ Greenish	No	No	Yes	Yes
Sharpness	Softer ◀▶ Sharper	No	Yes	Yes	Yes
R-level	Less red ◀▶ More red	Yes	Yes	Yes	Yes
G-level	Less green ◀▶ More green	Yes	Yes	Yes	Yes
B-level	Less blue ◀▶ More blue	Yes	Yes	Yes	Yes
Up/down shift ^[Note 2]	Shift down ◀▶ Shift up	No	Yes	Yes	Yes

Notes

- 1: **Tint** can only be adjusted when **Video mode** [p.24](#) is set to **NTSC** or **NTSC4.43**.
- 2: **Up/down shift** can only be adjusted when **Screen size** [p.31](#) is set **Wide**.

■ The default setting menu

This menu shows placement status and other settings.

Item ▲▼	Description
Projection mode	Sets projection mode in accordance with Placement Style p.18 (Placed on floor) ◀▶ (Rear) ◀▶ (Hung from ceiling) ◀▶ (Back hung from ceiling)
No signal power off	Sets the period of time to wait until turning off the power after signal input stops: Off (not turned off) ◀▶ 1 min ◀▶ 2 min ◀▶ ... ◀▶ 60 min
Power on	Sets whether to turn on the power when the ON/STANDBY button is pressed (Manual), or when the AC power cord is plugged in (Auto). Manual ◀▶ Auto
Lamp power ^[Note 1]	Sets the lamp power Standard ◀▶ Low

Note

- 1: When **Lamp power** is set to **low**, the screen becomes a little darker, but the cooling fan noise gets quieter.

■ Notes

- Note that if **Power on** is set to **Auto**, then if the AC power cord is plugged in when power is restored after a power outage, the projector power will come on.
- Even if **Power on** is set to **Auto**, press the **ON/STANDBY** button to turn off the power. Unplugging the AC power cord to cut off the power will shorten the life of the lamp.

■ The display setting menu

Use this menu to set screen display-related items.

Item ▲▼	Description
Screen size	◀▶ ◀▶ (Full): Display with LCD panel's resolution (Thru): Display with sampling resolution (for computer input) (Wide): Wide-screen display (for Video, S-video, and Y/P _B /P _R)
Language	Select one of the languages below to use for displaying menus and messages [▶]: Enter setting mode → [▲▼]: Selection → [Apply: ◀]] English/Français/Deutsch/Italiano/Español/ Português/日本語/中文(简体字)/中文(繁体字)/한국어
Background	Screen to display when there is no input signal (Logo) ◀▶ (Blue) ◀▶ (None)
Icon	Display icons as function guides On ◀▶ Off
Start-up screen	Display start-up screen when power turned on On ◀▶ Off

■ Notes

- If “Thru” is selected for **screen size**, portions exceeding the pixel count of the LCD panel [p.37](#) will not appear on the screen. Note that for RGB signals with clock speeds **SXGA3_60** [p.38](#) or lower, all input pixel signals are sampled. However, if the clock speed is higher than this, the RGB pixel signal is reduced before sampling.
- Displaying the images with the aspect ratio different from the original with the purpose of other than the personal and private viewing, using the screen size menu may violate the copyright protected by the law.

■ Reset menu (Special menu)

When other menus are not displayed and the button is held down, the menu appears.

- Select **Reset All** and press the button to return all menu items to the factory settings.

Item ▲▼	Description
Reset all	Reset all menu items to their factory settings [▶]: Enter execution mode → [Yes ▲▼ No] → [Apply: ◀]

Air filter cleaning

The air filter prevents dust and debris from getting inside the projector. Never run the projector with the filter removed. It is recommended that the air filter is cleaned regularly.

- The icon message “Check the air filter for dirt.” is displayed every 100 hours. (If the usage time exceeds 100 hours, this message is displayed for 30 seconds when the image is displayed for the first time after power is turned on. This display will be dismissed with any operation.)
- Check out the filter and any debris is found, use the following procedure for cleaning.

⚠ WARNING

- Request cleaning and maintenance of a ceiling-mounted unit from your projector dealership.

1 Unplug AC power cord.

2 Remove the air filter.

Pull out the air filter by taking the catch shown in the figure.

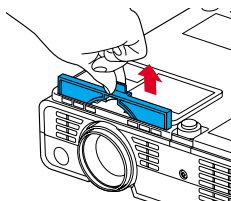

3 Clean the filter.

Carefully remove the dust and dirt from the air filter with a vacuum cleaner or the like.

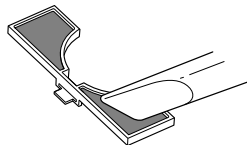

4 Replace the air filter.

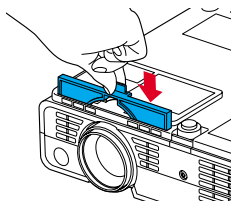

■ Notes

- Allowing dirt and dust to build up in the air filter will worsen the air circulation inside the projector, causing the internal temperature to rise, causing the projector to stop working or malfunction.
- Insert the air filter all the way in. Leaving gaps will allow dust and dirt to get inside the projector again.
- If you wash the air filter with water, make sure to dry it completely before replacing it.
- If the air filter is torn, consult with your dealer about replacing it with a new one. Continuing to use a ripped filter will allow dust and dirt to get inside the projector.

Lens and main unit cleaning

⚠ WARNING

- Request cleaning and maintenance of a ceiling-mounted unit from your projector dealership.

■ Lens cleaning

- Clean the lens with a commercially available blower and/or lens cleaner.
- The lens is easily scratched, so do not rub it with hard objects, or strike it.

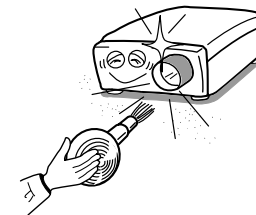

■ Main unit cleaning

- Clean the main unit after unplugging the AC power cord.
- Wipe dirt off the main unit gently with a soft cloth.
- If the soiling is severe, dip the cloth in a neutral detergent diluted in water, wring well, and gently wipe off the dirt, then finish up by wiping with a dry cloth.

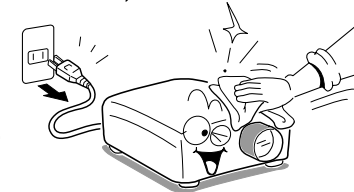

● Replacing air intake and exhaust fans, and air filter

To maintain the performance, it is recommended that these should be replaced about every 2 to 3 years. Consult with your dealer for details.

Lamp replacement

A lamp is consumable supplies. If used for extended periods, images will appear dark, and the lamp could burn out. This is characteristic of a lamp, and is not malfunction. (The lifetime of the lamp depends on condition of use.) If this happens, replace it with a new one.

⚠ WARNING

- If the projector is mounted on a ceiling, request a lamp replacement from your projector dealership.
- When replacing, always use lamp “VLT-SE1LP” (sold separately).

⚠ CAUTION

- If you have been using the projector, the lamp will be very hot, and may cause burn injuries. Wait for the lamp to cool (for longer than 1 hour) before replacing it.
- If the lamp should break, please handle with care to avoid injury due to broken pieces and contact your dealer for repair service.

1 Unplug AC power cord.

2 Wait until lamp is sufficiently cooled.

Wait for at least 1 hour.

Lamp replacement (Continued)

3 Remove the lamp cover.

Loosen the 2 screws, then pull up to the direction of the arrow with your fingers on the area shown in the figure to remove the lamp cover.

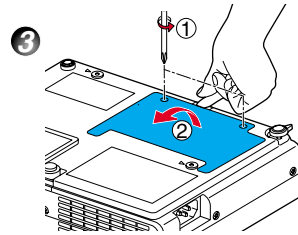

4 Pull out the lamp.

Loosen the 2 screws holding the lamp in place, and pull up the handle to remove the lamp.

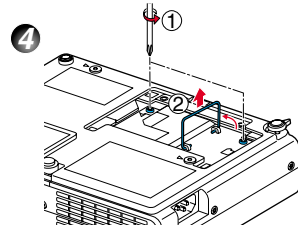

5 Mount the new lamp.

Align the orientation, press down until the bottom is reached, and lock in place using the two lamp locking screws.

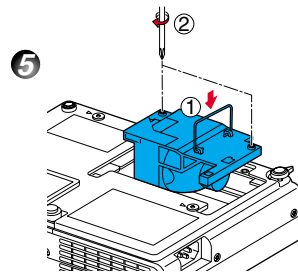

6 Replace the lamp cover.

Align the cover, and press it in, then tighten the screws loosened in step 3 until the lamp cover is no longer loose.

7 Reset the lamp timer.

See the lamp's manual for instructions on resetting the lamp timer.

Notes and Precautions

- Press the button twice to display (a rough guide) the time of lamp use, the **Lamp time** item, in the **Status display menu**. [p.28](#)
- It is recommended that the lamp should be replaced after 2,000 hours of use. When **Lamp time** reaches 2,000 hours, the icon and a message will appear. This display disappears when you press button.
- Attach the lamp cover correctly so that it is not loose. If it is not attached correctly, the lamp may fail to come on [p.35](#), and the lamp's lifetime may be shortened.
- Always replace the lamp with a new one.
- The lamp is made out of glass. Do not touch the glass surface with your bare hands, bang it, or scratch it. (Dirt, jolts, scratches and the like could break the lamp.)

Used Lamps

This projector's lamps contain trace amounts of environmentally harmful inorganic mercury. Be careful not to break used lamps, and dispose it in accordance with local regulations.

Trouble indications

The indicator lights inform you of internal abnormalities.

<p>FAN TEMP LAMP POWER (Off)</p>	<p>No power ⇒ Problem with projector • Unplug the AC power cord, and contact your dealer.</p>
<p>FAN TEMP LAMP POWER (Red lit) (Red lit)</p>	<p>Lamp went out during use, or won't come on ⇒ Lamp temperature is high so that it is difficult to turn on, the lifetime of the lamp has ended or the projector is malfunctioning. • Unplug the AC power cord and wait for a short while, then turn the power back on. • If a lamp burns out, replace it with a new one. * After approx. one minute of abnormal display, the projector returns to the standby state waiting for internal cool down.</p>
<p>FAN TEMP LAMP POWER (Green lit) (Red lit) (Red lit) Or (Off) Or (Orange lit) Or (Green lit)</p>	<p>Power went out during use ⇒ Internal overheating, or the outside temperature is too high. • Place the projector so that the air intake and exhaust are not blocked. • Unplug the AC power cord and wait for a short while, then turn the power back on. • Clean the air filter. p.32 * The icon will appear before the power goes out. * After approx. one minute of abnormal display, the projector returns to the standby state waiting for internal cool down.</p>
<p>FAN TEMP LAMP POWER (Red lit or flashing) (Red lit) Or (Orange lit or flashing)</p>	<p>Power went out during use ⇒ Problem with internal cooling fan. • Unplug the AC power cord, and contact your dealer. * The icon will appear before the power goes out. * After approx. one minute of abnormal display, the projector returns to the standby state waiting for internal cool down.</p>
<p>FAN TEMP LAMP POWER (Orange flashing) (Red lit)</p>	<p>Power went out during use, or power won't come on ⇒ The lamp cover is not properly attached. • Unplug the AC power cord, and reattach the lamp cover. p.34 * After approx. one minute of abnormal display, the projector returns to the standby state waiting for internal cool down.</p>

PRECAUTIONS

- Make sure to unplug the AC power cord if something goes wrong.
- If the AC power cord is unplugged before cooling is complete, give the lamp enough time to cool before plugging it back in. If the lamp overheats, it may fail to light. Unplugging the AC power cord repeatedly when the temperature is high will shorten the life of the lamp. (Even if you are not concerned about lamp lifetime, the light may not come on if you do not wait at least 3 minutes.)

Before calling service personnel

If you think something is wrong, check the followings before contacting customer service. Please see “**Trouble indications**” [p.35](#) as well.

If This Happens	Check
No power	<ul style="list-style-type: none"> Is the AC power cord plugged in? Is it connected to the projector? Is the lamp cover loose? p.35
Power goes out during use	<ul style="list-style-type: none"> Is the ambient temperature high? p.35 Is the air filter clogged? p.35 Is the air intake or air exhaust blocked? p.35
No picture	<ul style="list-style-type: none"> Is the projector turned on? p.22 Is the mute function on? p.26 Is the brightness setting minimized? p.30 Are the connections set up correctly? p.19 Are all the connected devices functioning properly?
No audio	<ul style="list-style-type: none"> Is the projector turned on? p.22 Is the mute function on? p.26 Is the volume setting minimized? p.23 Are the connections set up correctly? p.19 Are all the connected devices functioning properly?
Picture not displayed correctly	<ul style="list-style-type: none"> Is the input signal supported by the projector? p.38 , p.39 Is the correct video mode selected? p.24 Is the correct signal format selected? p.24 Is the selecting of computer or Y/P_B/P_R input correct? p.22 Is there something generating an abnormal video signal, for instance the video tape?
Picture blurred Part of picture out of focus	<ul style="list-style-type: none"> Is the lens dirty? p.33 Is the lens focus adjusted optimally? p.23 Is the projection distance within the projector's supported range? p.18 Is the projector's screen placement angle tilted too far? p.18 Are the sharpness or sampling phase adjustments off? p.24 p.30
Image is dark	<ul style="list-style-type: none"> Are the brightness or contrast adjustments off? p.30 Is the lamp nearing the end of its service life? p.30
Colors too light Bad shading	<ul style="list-style-type: none"> Are the color, tint, R-level, G-level, or B-level adjustments off? p.30 Is the screen dirty? Is the lamp nearing the end of its service life? p.28
Remote control doesn't work	<ul style="list-style-type: none"> Are the remote control's batteries drained? Are the batteries inserted into the remote control correctly? p.17 Is the remote control being used within the effective range? p.17 Are there any obstructions between the remote control and projector? Are there any fluorescent or other bright lights shining at the projector's infrared remote sensor?
Afterimages persist on the screen	<ul style="list-style-type: none"> This phenomenon is improved by keeping projecting an evenly bright image. (Such “image burn-in” phenomenon where afterimages persist on the screen may occur if a stationary image is kept displayed on the screen for a long time.)

Specifications

List of general specifications

Item	Specification	
Type	LCD Projector	
Model	SE1U	
Rated Input	2.4 A	
Rated Power Supply	100 - 240V AC, 50/60 Hz	
Weight	2.1 kg	
Outside Dimensions (including protruding parts)	303 × 84 × 206 mm (W × H × D)	
Cabinet material*	PC+ABS resin and ABS resin	
Temperature, Humidity (performance guaranteed)	Temp: +32°F (0°C) to +95°F (35°C); Relative humidity: 30% to 70%	
LCD Panel	Display method	3-panel transmission
	Panel size	0.5 type
	Drive system	TFT active matrix
	Picture elements	480,000 pixels (800H × 600V)
Projection Lens	F=1.8 f = 21.4mm	
Light Source Lamp	High-pressure mercury lamp 130 W	
Projection screen size	40-300 type	
Projection distance	1.5-11.6 m	
Speaker	1 W (Monaural)	
Connection terminal	COMPUTER terminal	Mini D sub 15 pin RGB / Y/P _B /P _R (dual use)
	COMPUTER OUT terminal	Mini D sub 15 pin RGB / Y/P _B /P _R (dual use)
	S-VIDEO terminal	Mini DIN 4 pin
	VIDEO terminal	RCA Pin Jack, 1 V (p-p), 75 Ω
	AUDIO terminal	3.5mm dia. stereo mini-jack, 1.5V (rms); 22 kΩ or more
	SERIAL terminal	Mini DIN 8 pin (RS-232C)

* Each plastic part displays the materials it is made from, in order to facilitate recycling after this product becomes no longer usable.

Separately Sold Product

Replacement Lamp Model VLT-SE1LP

Note

- Design, specifications, etc. subject to change without notice for improvements, etc.

Specifications (Continued)

List of supported signals (RGB signals)

This projector supports the following RGB signals. Note, however, that depending on the computer model, the screen may show flicker or streaking. Please adjust the projector if this happens.

(Press the AUTO POSITION button, and adjust automatically or manually. [p.24](#))

Resolution	Mode	Refresh rate (Hz)	H-frequency (kHz)	Clock (MHz)
720 x 400	720x400_85	85.039	37.927	35.500
640 x 480	VGA_60	59.940	31.469	25.175
	VGA_72	72.809	37.861	31.500
	VGA_75	75.000	37.500	31.500
	VGA_85	85.008	43.269	36.000
800 x 600	SVGA_56	56.250	35.156	36.000
	SVGA_60	60.317	37.879	40.000
	SVGA_72	72.188	48.077	50.000
	SVGA_75	75.000	46.875	49.500
	SVGA_85	85.061	53.674	56.250
832 x 624	MAC16"	74.550	49.725	57.283
1024 x 768	XGA_43i	86.957	35.522	44.900
	XGA_60	60.004	48.363	65.000
	XGA_70	70.069	56.476	75.000
	XGA_75	75.029	60.023	78.750
	XGA_85	84.997	68.667	94.500
	MAC19"	74.700	60.134	79.857
1152 x 864	SXGA1_75	75.000	67.500	108.000
1280 x 960	QuadVGA_60	60.000	60.000	108.000
	QuadVGA_85	85.002	85.938	148.500
1280 x 1024	SXGA3_60	60.020	63.981	108.000
	SXGA3_75	75.025	79.976	135.000
	SXGA3_85	85.024	91.146	157.500
1400 x 1050	SXGA+	60.012	63.973	118.094
1600 x 1200	UXGA_60	60.000	75.000	162.000
	UXGA_65	65.000	81.250	175.500
	UXGA_70	70.000	87.500	189.000
	UXGA_75	75.000	93.750	202.500
	UXGA_85	85.000	106.250	229.500
1792 x 1344	1792x1344_60	60.000	83.640	204.750
1856 x 1392	1856x1392_60	60.000	86.333	218.250
1920 x 1440	1920x1440_60	60.000	90.000	234.000

Note

- Signals whose resolution exceeds the LCD panel's number of pixels [p.37](#) will be compressed. For this reason, some information may be lost, or image quality may be affected.

List of supported signals (Y/P_B/P_R signals)

Signal format	fh(kHz)	fv(Hz)
480i(525i)@60Hz	15.73	59.94
480p(525p)@60Hz	31.47	59.94
576i(625i)@50Hz	15.63	50.00
576p(625p)@50Hz	31.25	50.00
720p(750p)@60Hz	45.00	60.00
720p(750p)@50Hz	37.50	50.00
1080i(1125i)@60Hz	33.75	60.00
1080i(1125i)@50Hz	28.13	50.00
1035i(1125i)@60Hz	33.75	60.00
1152i(1250i)@50Hz	31.25	50.00

List of supported signals (Video, S-Video signals)

Video mode	fh(kHz)	fv(Hz)	fsc(MHz)
NTSC	15.73	60	3.58
PAL	15.63	50	4.43
SECAM	15.63	50	4.25 or 4.41
PAL-M	15.73	60	3.58
PAL-N	15.63	50	3.58
PAL-60	15.73	60	4.43
NTSC4.43	15.73	60	4.43

Pin assignment of COMPUTER & COMPUTER OUT terminals

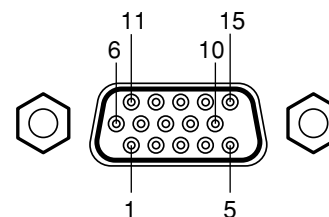

Mini D sub 15 Pin connector
Input Signal

- RGB input
 - R/G/B signals: 0.7V (p-p) 75 Ω
 - Horizontal sync signal: TTL level (Pos/neg polarity)
 - Vertical sync signal: TTL level (Pos/neg polarity)
- Y/P_B/P_R input
 - Y signal: 1.0V (p-p) 75 Ω
 - P_B/P_R signals: 0.7V (p-p) 75 Ω

Pin No.	Pin description	
	During RGB input	During Y/P _B /P _R input
1	Video signal (R)	Color difference signal (P _R)
2	Video signal (G)	Luminance signal (Y)
3	Video signal (B)	Color difference signal (P _B)
4	GND	*
5	GND	*
6	GND (R)	GND (P _R)
7	GND (G)	GND (Y)
8	GND (B)	GND (P _B)
9	N.C	*
10	GND	*
11	GND	*
12	N.C	*
13	Horizontal sync signal	*
14	Vertical sync signal	*
15	N.C	*

* Do not connect anything.

Specifications (Continued)

■ SERIAL terminal

● Pin assignment

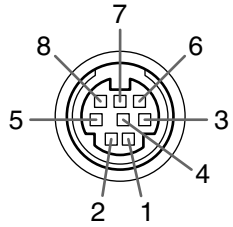

Mini DIN 8 pin connector

Pin No.	Signal Name	Description
1	RXD	Receiving data
2	CTS	Consent to send
3	DSR	Data set ready
4	GND	Signal ground
5	RTS	Request to send
6	Reserved	Do not connect anything
7	TXD	Sending data
8	GND	Signal ground

● Interface format

- 1 Communication method RS-232C, 9600bps, No Parity, Data Length: 8 bits;
Stop Bit Length: 1 bit
- 2 Communication format

STX (02h)	Command (3Byte)	ETX (03h)
-----------	-----------------	-----------

Only 1 command valid per communication.
- 3 Data format For input commands, only ASCII-compliant all-uppercase alphanumeric characters supported.
- 4 Replies

Acknowledge	ACK (06h)	CR (0Dh)	Data	... Normally ended
	ACK (06h)	ESC (1Bh)		... Aborted
No acknowledge	NAK (15h)			

If commands are to be sent consecutively, wait for the response from the projector before sending the next command.

● Main Commands

Item	Command
Power on	PON
Power off	POF
Icon display on	MO0
Icon display off	MO1
Auto setting (RGB input)	PAT
Status display on	DON
Status display off	DOF

Item	Command
Computer input select	IN1
Y/Pb/Pr input select	IN2
Video input select	IN3
S-video input select	IN4

■ Note

- Contact your dealer for control cable and other commands.

MITSUBISHI Projector Contact Information

North America

MESCA (Mitsubishi Electric Sales Canada Inc.)
<http://www.mitsubishielec.ca>
Information Technologies Group, 4299 14th Avenue, Markham, Ontario L3R 0J2, Canada

Sales Phone :+1-(905) 475-7728
Fax :+1-(905) 475-7958
E-mail :projectors@mitsubishielec.ca
Technical Phone :+1-(905) 475-7728
Fax :+1-(905) 475-7958

Customer Care E-mail :support@mitsubishielec.ca

MDEA (Mitsubishi Digital Electronics America, Inc.)
(Warranty Registration)
<http://www.mitsubishi-presentations.com/>
Presentation Products Division, 9351 Jeronimo Road, Irvine, CA 92618 U.S.A.
Phone Main Line :+1-(949) 465-6000
Technical :+1-(888) 307-0309
Product Information :+1-(888) 307-0312

Technical Support E-mail :tsupport@mdea.mea.com

Europe

MEU-FRA (Mitsubishi Electric Europe B.V French Branch)
25, Boulevard des Bouvets 92 741, Nanterre CEDEX, France
Sales Phone :+33 (0)1 55-68-55-07
Fax :+33 (0)1 55-68-57-31
Technical Phone :+33 (0)1 41-02-83-24
Fax :+33 (0)1 49-01-07-23

MEU-GER (Mitsubishi Electric Europe B.V German Branch)
<http://www.mitsubishielec-ews.de/>
Gothaer Strasse 8, 40880 Ratingen, Germany

MEU-IR (Mitsubishi Electric Europe B.V Irish Branch)
<http://www.mitsubishi.ie/>
Westgate Business Park, Ballymount, Dublin 24, Ireland
Sales Phone :+353-(0)1-4198844
Fax :+353-(0)1-4198842
Technical Phone :+353-(0)1-4198807
Fax :+353-(0)1-4198895

MEU-IT (Mitsubishi Electric Europe B.V Italian Branch)
Centro Direzionale Colleoni, Palazzo Persero-Ingresso 2, Via Paracelso 12, 20041 Agrate Brianza, Italy
Sales Phone :+39-(0)39-60531
Fax :+39-(0)39-6053214
E-mail :info.projector@it.mee.com

MEU-NL (Mitsubishi Electric Europe B.V Benelux Branch)
<http://www.mitsubishi.nl/CD/ProdFrame.html>
Nijverheidsweg 23a, 3641 RP Mijdrecht, The Netherlands
Sales Phone :+31-297-282461
Fax :+31-297-283936
E-mail :info.lec@nl.mee.com
Technical Phone :+31-297-282461
Fax :+31-297-283936
E-mail :info.lec@nl.mee.com

MEU (MITSUBISHI ELECTRIC EUROPE B.V.)
<http://www.mitsubishi-projector.ru/>
Moscow Representative Office, 12/1 Goncharnaya St. 109240, Moscow, Russia
Sales Phone :+7 (095) 915 8602
Fax :+7 (095) 915 8603

MEU-SP (Mitsubishi Electric Europe B.V Spanish Branch)
<http://www.mitsubishielec.es/>
Ctra. de Rubi, 76-80, 08190 Sant Cugat del Valles, Barcelona, Spain
Sales Phone :+34-93.565.31.54
Fax :+34-93.589.43.88
E-mail :mitsubishi_profesional@sp.mee.com
Technical Phone :+34-93.586.27.51
Fax :+34-93.639.74.45
E-mail :mitsubishi_profesional@sp.mee.com

MEU-SWE (Mitsubishi Electric Europe B.V Scandinavian Branch)
Hammarbacken 14, Box 750, S-19127, Sollentuna, Sweden
Sales Phone :+46-(0)8-6251070
Fax :+46-(0)8-6251036
Technical Phone :+46-(0)8-6251052
Fax :+46-(0)8-6251036

MEU-UK (Mitsubishi Electric Europe)
<http://www.mitsubishi.co.uk/news/>
Visual Information Systems Division, Travellers Lane, Hatfield, Hertfordshire, AL10 8XB
Sales Phone :+44 (1707) 278684
Fax :+44 (1707) 278541
E-mail :projector.info@meuk.mee.com
Technical Phone :+44 (870) 606 5008
Fax :+44 (1506) 431927
E-mail :projector.info@meuk.mee.com

Russia (Mitsubishi Electric Europe B.V Moscow Representative Office)
52, bldg.5, Kosmodamianskaya Nab, 113054, Moscow, Russian Federation
Sales Phone :+7 (095) 721 2070
Fax :+7 (095) 721 2071
Technical Phone :+7 (095) 721 2070
Fax :+7 (095) 721 2071

Asia

RIL (Ryoden (Holdings) Ltd.)
<http://www.ryoden.com.hk>
• Hong Kong Office
15/F, Manulife Tower, 169 Electric Road, North Point, Hong Kong, China
Technical Support
Phone :+852 6510 1750
Fax :+852 2887 8027
• Beijing Office
9/F, Office Tower 1, Henderson Centre, 18 Jianguomennei Dajie, Dongcheng District, Beijing, 100005, China
Sales & Technical Support
Phone :+86 (10) 6518 2930
Fax :+86 (10) 6518 2530
• Shanghai Office
10/F, Shanghai Square Office Tower, 138 Huai Hai Zhong Road, Lu Wan District, Shanghai, 200021, China
Sales & Technical Support
Phone :+86 (21) 6327 2225
Fax :+86 (21) 6327 4915
• Shenzhen Office
Unit 01-04, 13/F, Building A, Tian An International Building, Renmin Road South, Shenzhen, 518005, China
Sales & Technical Support
Phone :+86 (755) 518 6386
Fax :+86 (755) 218 4775
• Chengdu Office
Block B-1, 23/F, Chuan Xin Mansion, 18 Section 2, Renmin Road South, Chengdu, 610016, China
Sales & Technical Support
Phone :+86 (28) 619 9730
Fax :+86 (28) 619 9801

REMECO (Ryoden Merchandising Co., Ltd.)
<http://www.mitsubishi-ryoden.com.hk>
Units 5-10, 20th Floor, Tower 1, Ever Gain Plaza, 88 Container Port Road, Kwai Chung, N.T., Hong Kong, China
Sales Support Phone :+852 2510 2119
Fax :+852 2510 463
Technical Support Phone :+852 2510 2188
Sales & Technical Support E-mail :info.pav@remeco.meap.com

MEAP (Mitsubishi Electric Asia Pte Ltd)
<http://www.mitsubishielecric.com.sg>
307 Alexandra Road, Mitsubishi Electric Building, 289245, Singapore
Main Line Phone :+65 6 473 2308
Fax :+65 6 475 9503
Sales & Technical Support E-mail :peripherals@asia.meap.com

AMS (Antah Melco Sales & Services Sdn Bhd
(A Joint-Venture Company of Mitsubishi Electric Corporation))
<http://www.antahmelco.com.my>
6, Jalan 13/6, Petaling Jaya, Selangor Darul Ehsan, Malaysia
Main Line Phone :+603-7956 2088
Fax :+603-7956 3560
E-mail :+603-7958 2576

Technical Support :+603-7955 2088
Phone :+603-7955 2088
E-mail :anmelco@po.jaring.my
Product Information
Phone :+603-7955 2088

ME-TWN (Mitsubishi Electric Taiwan Co., Ltd.)
<http://www.mitsubishi-electric.com.tw>
9th Floor, 90 Sec. 6, Chung Shan N. Rd., Taipei, Taiwan
Sales Support Phone :+886 (0) 2 2832 8255
Fax :+886 (0) 2 2833 9813

KYW (Kang Yong Watana Co., Ltd.)
<http://www.mitsubishi-kyw.in.th>
28 Krungthep Kreetha Road, Huamark Bangkok, Bangkok, 10240, Thailand
Sales Support Phone :+66 (2) 731 6901
Fax :+66 (2) 379 4763

STC (Setsuyo Trading Co.Ltd. Seoul Branch)
Dongseo Game Channel Bldg, 660-11, Deungchon-dong, Kangseo-ku, Seoul, Korea
Main Line Phone :+82 (0) 2 3665 4964
Fax :+82 (0) 2 3665 4965

Oceania

ME-AUST (Mitsubishi Electric Australia)
<http://www.mitsubishi-electric.com.au/prod.asp?prod=proj>
348 Victoria Road, Rydalmere, N.S.W. 2116, Australia
Sales Phone :+(612)9684-7777
Fax :+(612)9898-0484
E-mail :ped@meaust.meap.com

MENZ (BDT Ltd)
(Warranty Registration) <http://www.bdt.co.nz/warranty.asp>
1 Parliament St., Lower Hutt, Wellington, New Zealand
Sales Phone :+64(0)4-560-9100
Fax :+64(0)4-560-9133
E-mail :help@bdt.co.nz
Technical Phone :+64(0)4-560-9100
Fax :+64(0)4-560-9133

 **MITSUBISHI ELECTRIC CORPORATION**
1 Zusho Baba, Nagaokakyo-City, Kyoto Japan